

Dirt separator

745-746

ST.74X.01.24.EN (NC 1067, NC1569)

/ Function

Dirt separators are used to constantly separate impurities from installation water of heating and cooling systems (sand, rust particles, etc.) gathering them in a large collection chamber from which they can be removed by opening a drain cock while the system is in operation.

Dirt separators are able to separate even the smallest impurities automatically. ICMA dirt separators guarantee an efficient operation of the heating and cooling systems significantly reducing obstructions in the pipes, heating elements and heat exchangers, thus preventing to affect their performances.

They also prevent rapid wear and damage of system components (such as pumps, valves, etc.) without causing any noise or overheating and with extremely limited pressure drops.

The magnetic dirt separators are also provided with a removable magnetic cartridge specifically designed to collect ferrous impurities within the system.



/ Products

Art.	Code	Connections
745	82745AE05	G 3/4" F
745	82745AF05	G 1" F
745	82745AG05	G 1"1/4 F
745	82745AH05	G 1"1/2 F
745	82745AJ05	G 2" F

Art.	Code	Connections
746	82746AE05*	G 3/4" F
746	82746AF05*	G 1" F
746	82746AG05*	G 1"1/4 F
746	82746AH05*	G 1"1/2 F
746	82746AJ05*	G 2" F



Products with * symbol have magnetic insert Art.744

/ Technical features

Body:	Brass CB 753 S - UNI EN 1982
Collection chamber:	Brass CB 753 S - UNI EN 1982
Upper cup:	Brass CW 617 N - UNI EN 12165
Internal element:	Stainless steel
Drain cock:	Composite materials
Sealing gaskets:	EPDM Peroxide (for high temperature)
Working fluid:	Water, glycol solutions
Max. percentage of glycol:	50%
Temperature range:	0°÷110°C
Max. operating pressure:	10 bar
Main connection:	G 3/4" - G 1" - G 1"1/4 - G 1"1/2
Top connection:	G 1/2"
Drain connection:	G 3/4" with hose connector Ø15
Magnet:	Neodymium REN35 B=10.500 Gauss

Dirt separator

745-746

/ Dimensions

Art.	Code	A	B	C	D	Ch. E	Ch. F	Ch. G
745	82745AE05	G 3/4" F	82	196	160	22	37	26
745	82745AF05	G 1" F	82	196	160	22	37	26
745	82745AG05	G 1"1/4 F	90	232,5	183,5	22	54	26
745	82745AH05	G 1"1/2 F	90	232,5	183,5	22	54	26
745	82745AJ05	G 2" F	116	261	224	22	67	21

Art.	Code	A	B	C	D	Ch. E	Ch. F	Ch. G
746	82746AE05	G 3/4" F	82	196	160	17	37	26
746	82746AF05	G 1" F	82	196	160	17	37	26
746	82746AG05	G 1"1/4 F	90	198	160	17	54	26
746	82746AH05	G 1"1/2 F	90	198	160	17	54	26
746	82746AJ05	G 2" F	116	261	224	17	67	21

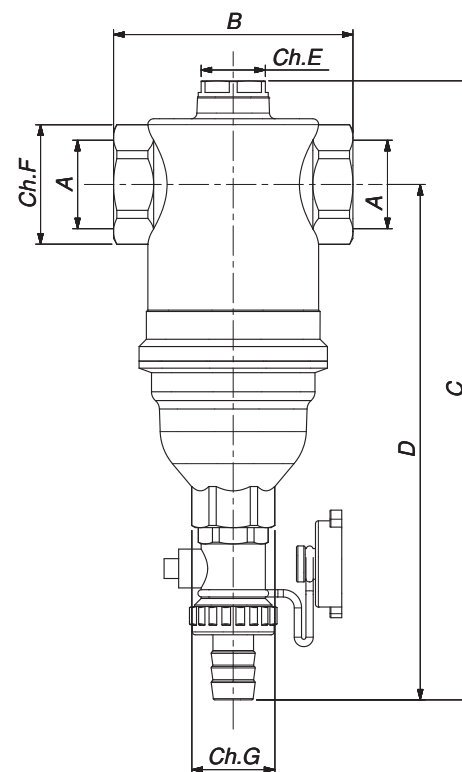

/ Hydraulic characteristics

The table below shows Kv parameters related to ICMA dirt separators

Size	3/4"	1"	1"1/4	1"1/2	2"
Kv (m3/h)	16,2	28,1	48,8	63,2	70

The maximum recommended flow speed is 1,2 m/s.
The following table shows the maximum flow rates in order to meet this requirement.

Size	3/4"	1"	1"1/4	1"1/2	2"
l/min	22,7	35,18	57,85	90,36	141,33
m3/h	1,36	2,11	3,47	5,42	8,48

/ Pressure drop diagram

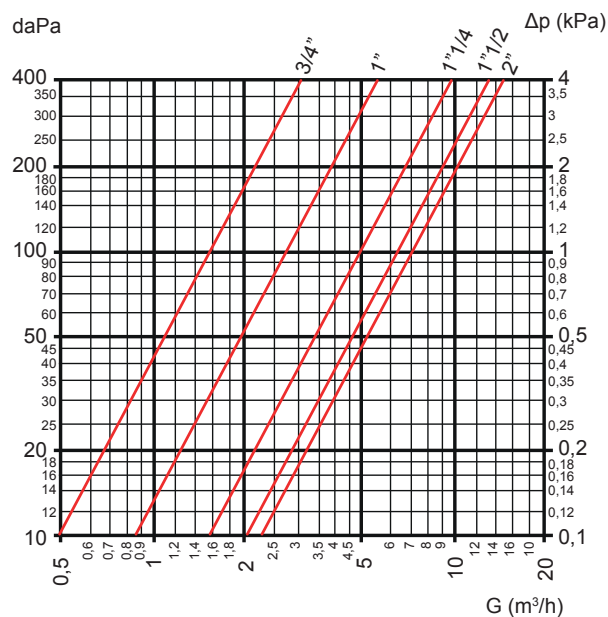

/ Application scheme

The dirt separator should preferably be installed on the return circuit upstream of the boiler (and of the pump) to intercept any impurities coming from the air conditioning circuit, especially when starting the system. The flow direction is not important in ICMA dirt separators.

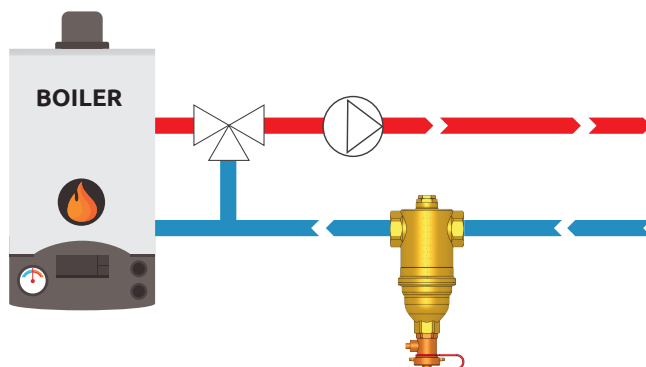
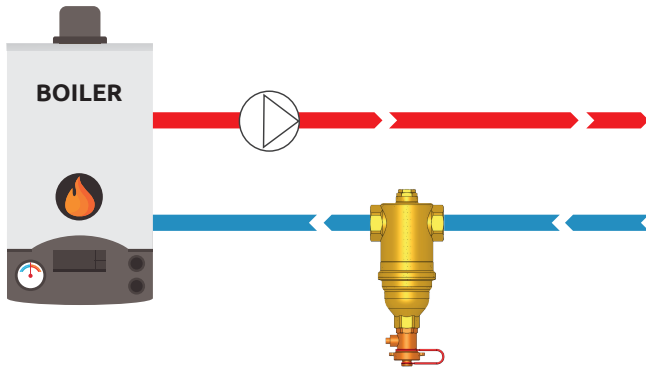

/ Installation

The dirt separator can only be installed vertically.

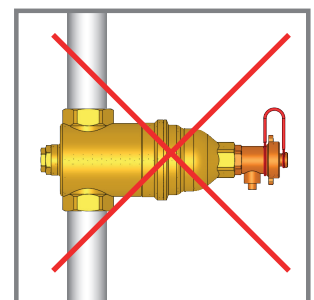
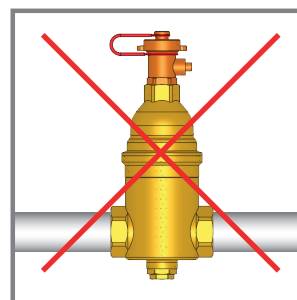
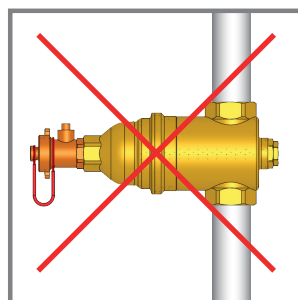
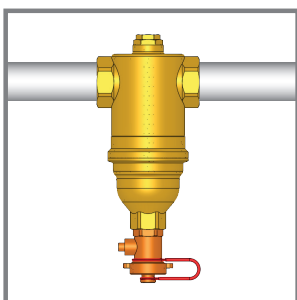

/ Safety



The installation of ICMA dirt separators must be done by qualified staff. During installation and maintenance of dirt separators attention must be paid to the fluids temperature which can be over 50° C causing serious burns. Remember that the guarantee will be forfeited in the event of any unauthorised changes or tampering with the device during assembly and construction.

/ Impurities discharge Art. 746

Remove the magnetic cartridge at the top of the dirt separator with a 17mm wrench (1) enabling the ferrous impurities to be collected by the dirt separator in the lower cup together with all other impurities.

To drain all the impurities collected by the dirt separator, simply unscrew the cap (1) screw the hose connector (2) and open the ball valve using the wrench on the cap (3).

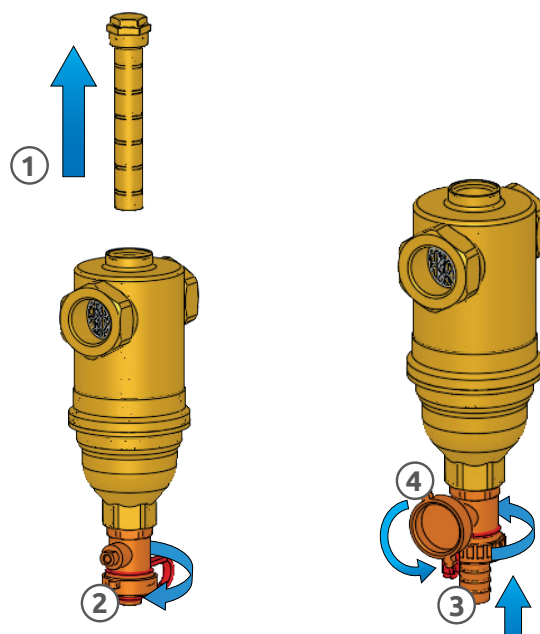

/ Impurities discharge Art. 745

To drain all the impurities collected by the dirt separator, simply unscrew the cap (1) screw the hose connector (2) and open the ball valve using the wrench on the cap (3).

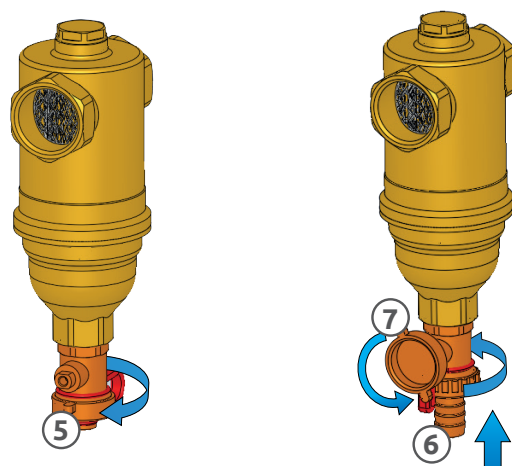

/ Impurities discharge for 2" dirt separator

The dirt separator size 2" has a drain cock with handle. Open it to discharge the impurities.

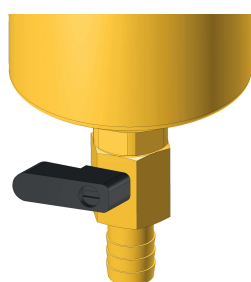

DRAIN COCK **CLOSED**



DRAIN COCK **OPEN**

/ Maintenance

Be careful with the sharp edges of the filter cartridge, we recommend the use of proper gloves.



/ Top connection

The dirt separator has a top threaded hole that can be used to install an "automatic air vent". To do that, simply remove the cap on top and install ICMA valve code:

- 82707AD05/06
- 82708AD05/06.

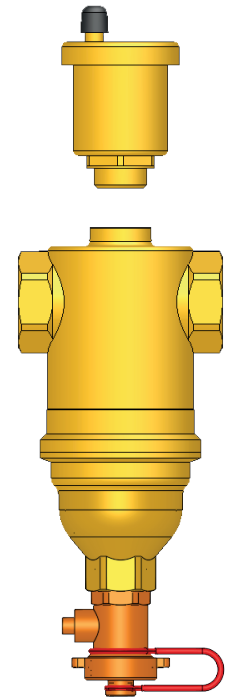

/ Conversion of art. 745 into art. 746

The dirt separator has a top threaded hole in which the 744 magnetic cartridge can be installed for conversion into a magnetic dirt separator.

- 82744AE05 for 3/4" and 1"
- 82744AG05 for 1" 1/4 and 1" 1/2.

